Meridian 1

M3900 Series Meridian Digital Telephones

Description, Installation and Administration

Document Number: 553-3001-216

Document Release: Standard 1.00

Date: June 1999

© 1999

All rights reserved

Printed in the United States of America

Information is subject to change without notice. Nortel Networks Corporation reserves the right to make changes in design or components as progress in engineering and manufacturing may warrant. This equipment has been tested and found to comply with the limits for a Class A digital device pursuant to Part 15 of the FCC rules, and the radio interference regulations of Industry Canada. These limits are designed to provide reasonable protection against harmful interference when the equipment is operated in a commercial environment. This equipment generates, uses and can radiate radio frequency energy, and if not installed and used in accordance with the instruction manual, may cause harmful interference to radio communications. Operation of this equipment in a residential area is likely to cause harmful interference in which case the user will be required to correct the interference at their own expense.

SL-1 and Meridian 1 are trademarks of Nortel Networks Corporation.

Revision history

June 1999

Standard 1.00.

Contents

Preface	1
Other documentation	1
Functional description	3
General features	4
Feature keys	4
M3901 Entry Telephone	8
M3902 Basic Telephone	9
M3903 Enhanced Telephone	10
M3904 Professional Telephone	11
M3905 Call Center Telephone	13
Configure the M3900 Series Meridian Digital Telephone	15
Hardware options	25
Handset option for the M3905 Call Center Telephone	26
Headset options	26
External Alerter and Recording Interface	26
Key-based Expansion Module	26
Analog Terminal Adapter	26
Meridian Communications Adapter	27
Installation	29
To install the M3900 Series Meridian Digital Telephones:	29
To install the ACM:	29
Accessory keying	30

Telephone positions 32

Environmental and safety considerations 33

 Temperature and humidity 33

 Line engineering 34

List of Acronyms 35

List of figures

Figure 1	
M3901	8
Figure 2	
M3902	9
Figure 3	
M3903	10
Figure 4	
M3904	12
Figure 5	
M3905	13
Figure 6	
Installation of the Accessory Connection Module (ACM)	30

List of tables

Table 1	
Feature Key text and icon labels	4
Table 2	
LD 11 - Configure the M3900 Series Digital Telephone	15
Table 3	
M3901 key configuration	18
Table 4	
M3902 key configuration	19
Table 5	
M3903 key configuration	20
Table 6	
M3904 key configuration	21
Table 7	
M3905 key configuration	22
Table 8	
LD 20 - Configure print routine.	23
Table 9	
Hardware Features	25
Table 10	
M3900 Series Meridian Digital Telephone accessory compatibility . .	31

Preface

This guide provides feature, expansion module, and specification information for the M3900 Series Meridian Digital Telephones.

Other documentation

For more information, refer to the following documentation:

- *Digital telephone line engineering* (553-2201-180)
- *Meridian Communications Unit and Meridian Communications Adapter description, installation, administration, operation* (553-2731-109)
- *Spares planning* (553-3001-153)
- *Meridian 1 equipment identification* (553-3001-154)
- *Meridian 1 line cards description* (553-3001-105)
- *X11 features and services, International* (553-3001-306)
X11 features and services, North American (553-3001-305)
- *Software Input/Output Guide X11 Administration, International* (553-3001-311)
X11 input/output guide, North American (553-3001-400)
- *Software Input/Output Guide X11 System Messages* (553-3001-411)
- *Asynchronous Data user guide* (P0661883)

Functional description

This document introduces the M3900 Series Meridian Digital Telephones. It provides you with a description, installation and administration of the M3900 Series Telephone. Features for the five models are found on the following pages.

- Functional description of each telephone:
 - “M3901 Entry Telephone” on page 8
 - “M3902 Basic Telephone” on page 9
 - “M3903 Enhanced Telephone” on page 10
 - “M3904 Professional Telephone” on page 11
 - “M3905 Call Center Telephone” on page 13
- “General features” on page 4
- “Hardware options” on page 25
- “Configure the M3900 Series Meridian Digital Telephone” on page 15
- “Installation” on page 29
- “Environmental and safety considerations” on page 33

M3900 Series Meridian Digital Telephones provide integrated voice and data communication. The M3900 Series Telephones communicate with the Meridian 1 through digital transmission over standard twisted-pair wiring.

The M3900 Meridian Digital Telephone interfaces with the Digital Line Card (DLC) in the Intelligent Peripheral Equipment (IPE) shelf of the system. The DLC supports 16 voice and 16 data ports. The system software assigns a Terminal Number (TN) to each port in the system.

General features

The five models of the M3900 series telephones have specific characteristics. Refer to:

- “M3901 Entry Telephone” on page 8
- “M3902 Basic Telephone” on page 9
- “M3903 Enhanced Telephone” on page 10
- “M3904 Professional Telephone” on page 11,
- “M3905 Call Center Telephone” on page 13.

The M3900 Series Meridian Digital Telephones support features through:

- Fixed Feature Keys
- Programmable Line/Feature Keys (Self-labeled)
- Programmable Feature Keys (Self-labeled)

Feature keys

Fixed Feature Keys

The Fixed Feature Keys are the feature keys on your M3900 Series Meridian Digital Telephone that are pre-labeled with the assigned feature. The Fixed Feature Keys appear on the telephone with text or icon labels. Telephones with icon labels are only available in specific market areas. Refer to Table 1.

Table 1
Feature Key text and icon labels (Part 1 of 3)









Feature Key	Text label	Icon label
Goodbye		
Hold		
Mute		
Handsfree		
Volume	NA	

Table 1
Feature Key text and icon labels (Part 2 of 3)





























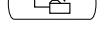





Feature Key	Text label	Icon label
Headset		
Options		
DN line		
Feature Key (M3901 only)		
Message		
Directory/Log		
Shift		
Application		
Navigation		
Copy		
Transfer		
InCalls		
Not Ready		
Make Busy		

Table 1
Feature Key text and icon labels (Part 3 of 3)

Feature Key	Text label	Icon label
Call Supervisor	<i>Supervisor</i>	
Answer Agent	<i>Ans Agent</i>	
Activity Key	<i>Activity</i>	
Answer Emergency	<i>Ans Emerg</i>	
Emergency	<i>Emergency</i>	
Call Log	<i>Call Log</i>	
Observe Agent	<i>Obv Agent</i>	
Display Calls Waiting	<i>Dsply Queue</i>	
Quit	<i>Quit</i>	NA

Note: Icon key labels are available in specific markets areas.

Programmable Line/Feature Keys (Self-labeled)

The Programmable Line/Feature Keys (Self-labeled) are the keys located at the left and right sides of the upper section of the display area. The user can change the LCD label of these keys (with the exception of the primary Directory Number Key) to meet their needs. The Programmable Keys (Self-labeled) are the keys located on both sides of the upper section of the display area of the M3903, M3904, and the M3905 model.

The Programmable Line/Feature Key (Self-labeled) provides two layers of functionality on the M3903, M3904. The two layer keys on the M3903 and M3904 provides the user access to two Lines/Features per key. For example the M3904 has six Programmable Line/Feature Keys (Self-labeled), which provide the user with 12 line/feature keys accessible on the six keys.

Programmable Feature Keys (Self-labeled)

The Programmable Feature Keys (Self-labeled) are the three to four keys located below the lower portion of the display area on your M3903, M3904, and M3905 Meridian Digital Telephone. The Programmable Feature Keys (Self-labeled) provide three layers of features to each feature key on the M3903, M3904, and M3905. The features assigned to these keys are shown in:

- Table 4, “M3902 key configuration,” on page 19
- Table 5, “M3903 key configuration,” on page 20
- Table 6 “M3904 key configuration” on page 21
- Table 7, “M3905 key configuration,” on page 22

Programmable Features

The M3901 can have five programmable features assigned. The user activates the features by pressing the Feature Key and assigned key pad keys as indicated by the Feature Card. The system administrator programs selected features for the M3901 telephone. For feature assignment information see Table 3, “M3901 key configuration,” on page 18.

Note: Icon key labels are available in distinct market areas

M3901 Entry Telephone

The features of the M3901 are:

- one line (Directory Number (DN)) capability
- five programmable features
- Feature Activation and Message Waiting and Incoming Call Status Indicator LED
- supports an amplified headset through the handset jack

Figure 1
M3901

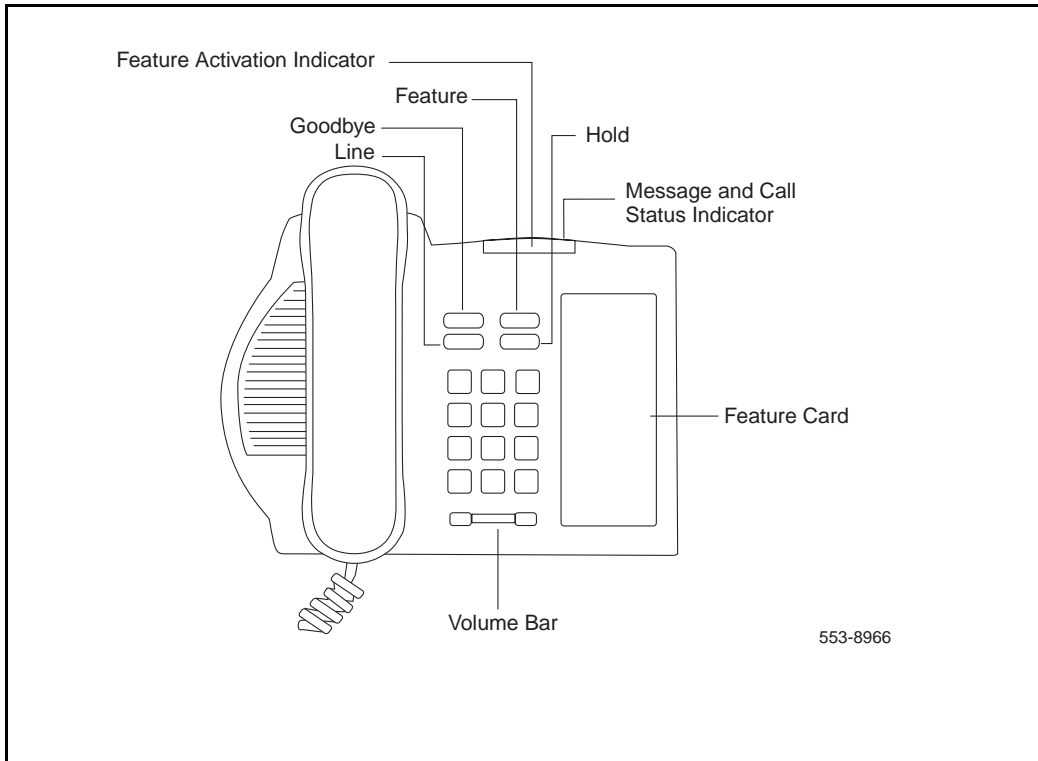

M3902 Basic Telephone

The features of the M3902 are:

- one line (Directory Number (DN) capability)
- three Programmable Feature Keys (Self-labeled)
- Fixed Feature Keys:
- two lines by 24 character display area
- handsfree calling option
- Group Listening
- on-hook dialing
- supports an amplified headset through handset jack
- one accessory port

Figure 2
M3902

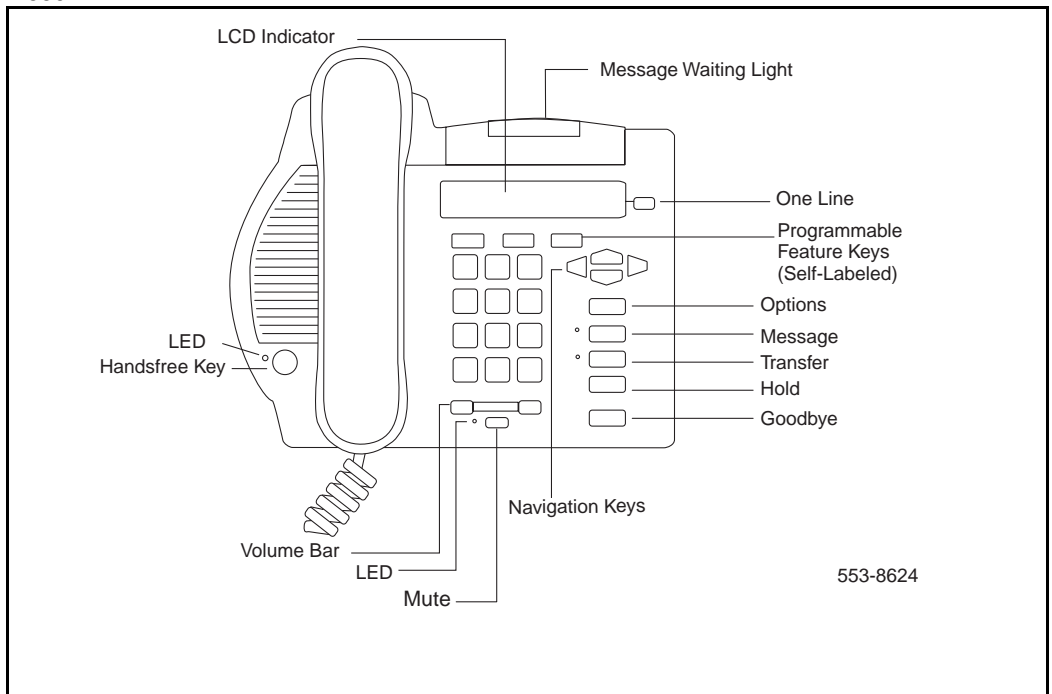

M3903 Enhanced Telephone

The features of the M3903 are:

- two Programmable Line/Feature Keys (Self-labeled) which provide two layers each, giving the user access to four line/feature keys
- four Programmable Feature Keys (Self-labeled) which have three layers each, giving the user access to 12 feature keys
- Fixed Feature Keys
- three line by 24 character display area Call Log
- Group Listening
- on-hook dialing
- two accessory ports
- a headset port
- handsfree calling

Figure 3
M3903

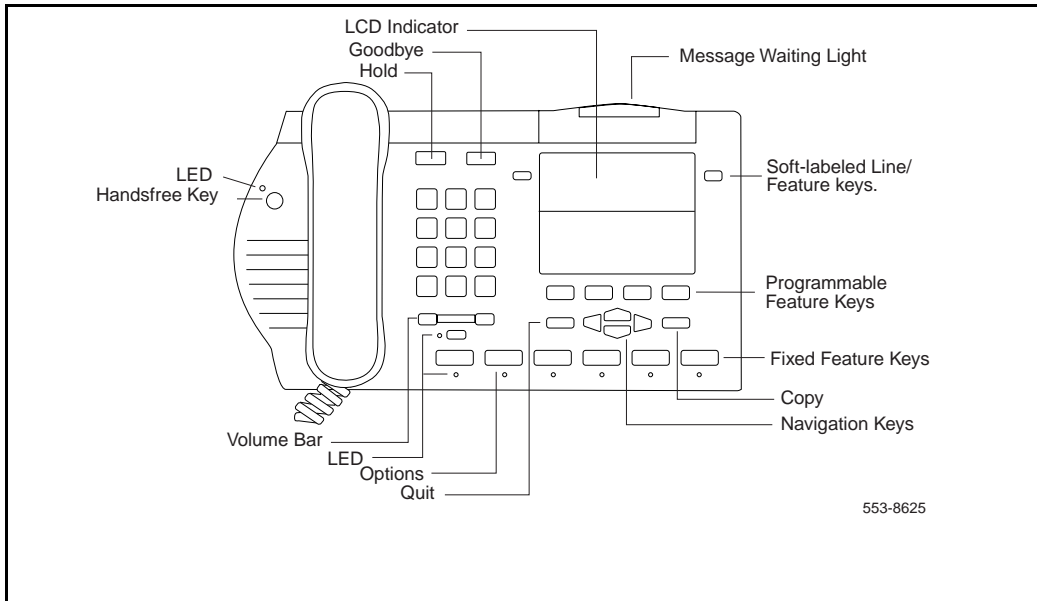

M3904 Professional Telephone

The features of the M3904 are:

- six Programmable Line/Feature Keys (Self-labeled) which have two layers each, giving the user access to 12 line/feature keys
- four Programmable Feature Keys (Self-labeled) which have three layers each, giving the user access to 12 feature keys
- Fixed Feature Keys:
 - four line by 24 character display
 - Personal Directory
 - Call Log
 - Group Listening
 - on-hook Dialing
 - two Accessory Ports
 - speaker Indicator
 - a headset port
 - handsfree calling option

Figure 4
M3904

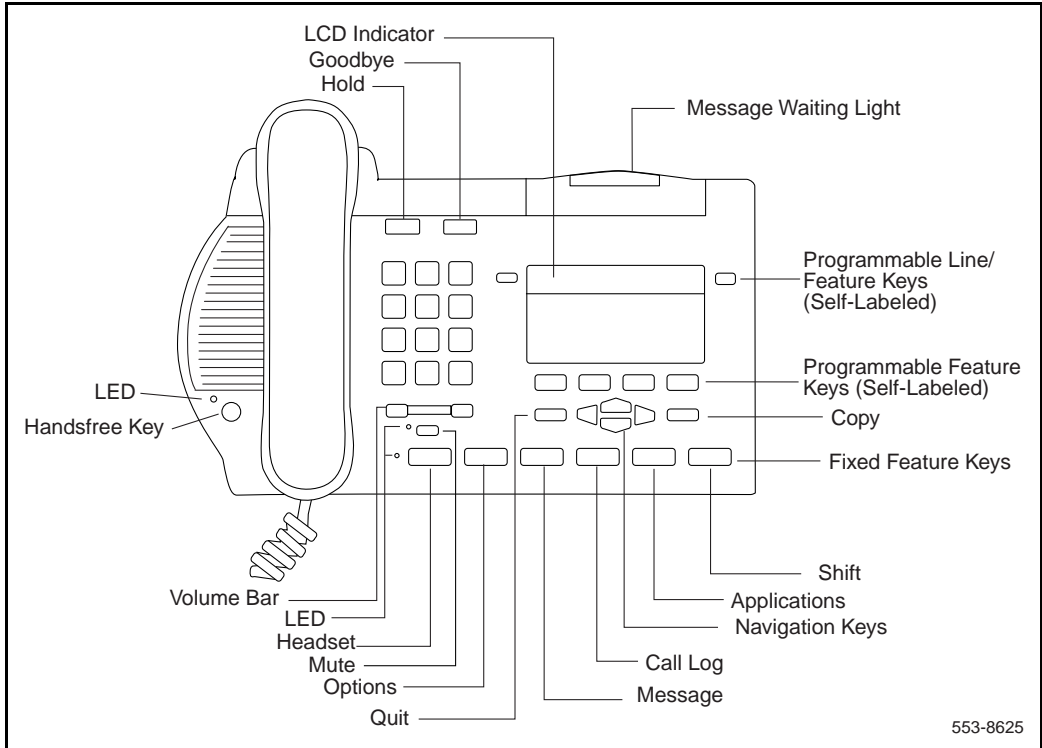

M3905 Call Center Telephone

The features of the M3905 Call Center Telephone are:

- eight Programmable Line/Feature Keys (Self-labeled), giving the user access to eight line/feature keys
- four Programmable Feature Keys (Self-Labeled) which have three layers each, giving the user access to 12 feature keys
- six Fixed Feature Keys
- Personal Directory
- Call Log
- five line by 24 character display
- handset optional
- Supervisor Observe Key with LED
- Supervisor Headset Observe port

Figure 5
M3905

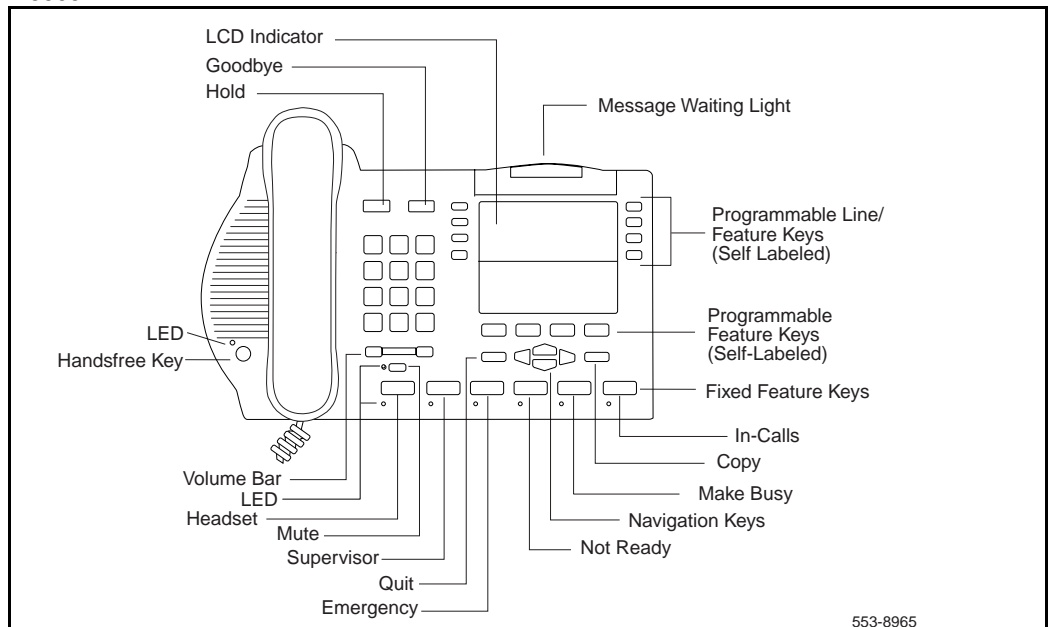

Note: You can configure four of the bottom six Fixed Feature Keys to feature Keys that suit the business needs of the Call Center user.

Configure the M3900 Series Meridian Digital Telephone

To configure the M3900 Series Meridian Digital Telephones follow these procedures:

- Configure the telephone type and class of service in LD 11.
- Configure the feature keys in LD 11
- Configure the Print request in LD 20

Table 2

LD 11 - Configure the M3900 Series Digital Telephone (Part 1 of 3)

Prompt	Response	Comments
REQ:	NEW CHG	Input new data. Change current data.
TYPE:	x..x	Type of telephone. 3901 = M3901. 3902 = M3902. 3903 = M3903. 3904 = M3904. 3905 = M3905.
TN	lscu cu	Terminal number. l = loop address. s = shelf address. c = card address. u = unit address. For Option 11C input only the card and unit address. Note 1: If the telephone has an Analog Terminal Adapter (ATA), then you can use the voice Terminal Numbers can 16-31.

Table 2
LD 11 - Configure the M3900 Series Digital Telephone (Part 2 of 3)

Prompt	Response	Comments
DES	d...d	Designator The response d...d represents an Office Data Administration System (ODAS) Station Designator of 1-6 alphanumeric characters.
CUST	xx	Customer number as defined in LD 15.
KBA	(0)-2	Key-based Expansion Module accessory prompt. This prompt appears when the set type is M3904 and M3905.
FDN	xxx...x	Flexible CFNA DN.
...
scpw	xxx...x	Station Control password.
...
CLS	aaaa	Class of Service options where: aaaa, = ADD-Automatic Digit Display, default M3902, M3903, M3904 & M3905. = (GRLD) Group Listening Denied, (M3902, M3903, M3904, M3905). = (GRLA) Group Listening Allowed, (M3902, M3903, M3904, M3905). = (HFD) Handsfree Denied, M3902, M3903 & M3904). = HFA Handsfree Allowed (M3902, M3903 & M3904). = (FLXD) FLXA, required if ATA equipped. = (VCE), DTA - voice, data terminal, required if ATA equipped. Note 2: The Class of Service (CLS) must = flxa and vce if ATA equipped.
DTAO	(mpda), mca	Data Option. MPDA = Meridian Data Adaptor. MCA = Meridian Communications Adaptor.

Table 2
LD 11 - Configure the M3900 Series Digital Telephone (Part 3 of 3)

Prompt	Response	Comments
- BAUD	(0)-(7)-10	Baud rate. Prompt appears if CLS = Data (DTA) and Open (OPE) = yes. Enter data rate where: 9 = 28800 new baud rate for M3900 sets.
...
KEY	xx aaa yyy zzz	Telephone function key assignments where: xx = key number. aaa = key name or function. yyy, zzz = additional information required. Note 3: Refer to the each telephone feature key tables which detail feature key defaults and assignments for: <ul style="list-style-type: none"> • "M3901 key configuration" on page 18. • "M3902 key configuration" on page 19. • "M3903 key configuration" on page 20. • "M3904 key configuration" on page 21. • "M3905 key configuration" on page 22. Note 4: MTAD (Meridian 1 Time and Date) -The system puts a block on the time and date key on all the M3900 Series Meridian Digital Telephones.

Table 3
M3901 key configuration

Key Number	Description
Key 0	Line (Directory Number). Note 1: You can configure Key 0 as a Voice Call (VCC) or HotLine (HOT) Key.
Key 1	Feature or Auto Dial.
Key 2	Feature or Auto Dial.
Key 3	Feature or Auto Dial.
Key 4	Feature or Auto Dial.
Key 5	Feature or Auto Dial. Note 2: You can configure Keys 1 - 5 with any features that does not require a display (DAG, DWG, DSP and RMK).
#	Deactivate all activated features.
other	Illegal or not defined. Note 3: The M3901 telephone firmware controls the Volume Control Bar, and the Hold, and Goodbye Keys. Do not configure on the Meridian 1 System. Note 4: Nortel Networks recommends that you do not configure the M3901 Call Center DN.

Table 4
M3902 key configuration

Key Number	Description
Key 0	Directory Number line must go on Key 0.
Key 4	TRN (Call Transfer).
Key 5	MWK (Message Waiting).
Key 1-5	Key 1-5 do not configure as: MCN = Multiple Call Non-ringing. MCR = Multiple Call Ringing. PVN = Private Line Non-ringing. PVR = Private Line Ringing. SCN = Single Call Non-ringing. SCR = Single Call Ringing.

Table 5
M3903 key configuration

Key Number	Description
Keys 12-15	Blocked.
Key 16	MWK (Message Waiting).
Key 17	TRN (Call Transfer).
Key 18	A03 (3 Party Conference) or the A06 (6 Party Conference).
Key 19	CFW (Call Forward).
Key 20	RGA (Ring Again).
Key 21	PRK (Call Park).
Key 22	RNP (Ringing Number Pick-up).
Key 23	Configure as: SCU = Speed Call. SSU = System Speed Call. SCC = Speed Call Controller. SSC = System Speed Call Controller. Note: .not blocked as programmable keys.
Key 24	PRS (Privacy Release).
Key 25	CHG (Charge Account).
Key 26	Calling Party number.
Keys 27-31	NUL.

Table 6
M3904 key configuration

Key Number	Description
Keys 12-15	Blocked.
Key 16	MWK (Message Waiting is not a default feature for this key).
Key 17	TRN (Call Transfer).
Key 18	A03 (3 Party Conference) or the A06 (6 Party Conference).
Key 19	CFW (Call Forward).
Key 20	RGA (Ring Again).
Key 21	PRK (Call Park).
Key 22	RNP (Ringing Number Pick-up).
Key 23	Configure as one of the following: <ul style="list-style-type: none"> • SCU = Speed Call. • SSU = System Speed Call. • SCC = Speed Call Controller. • SSC = System Speed Call Controller. <p>Note: The above services are not a default feature for this key. Can use these features on any of the programmable keys.</p>
Key 24	PRS (Privacy Release).
Key 25	CHG (Charge Account).
Key 26	CPN (Calling Party number).
Keys 27-31	NUL.

Table 7
M3905 key configuration (Part 1 of 2)

Key Number	Description
Key 5	Server application or NUL.
Key 6	Local application or NUL.
Key 7	Program Key or NUL.
Key 8-11	Configure as one of the following: AAG = Agent Answer. AMG = Answer Emergency Call. ASP = Supervisor call (must have CLS =AGN). EMR = Emergency (must have CLS = AGN). MSB = Make Set Busy. NRD = Not Ready (must have CLS = AGN or SPV). ACNT = Activity Code entry. DWC = Display Waiting Calls (used with supervisor or agent telephones). OBV = Observe agent. RAG = Ring Agent (must have CLS = SPV).
Key 16	MWK (Message Waiting is not a default feature key).
Key 17	TRN (Call Transfer) key.
Key 18	A03 (3 Party Conference) or the A06 (6 Party Conference).
Key 19	CFW (Call Forward).
Key 20	RGA (Ring Again).
Key 21	PRK (Call Park).
Key 22	RNP (Ringing Number Pick-up).
Key 23	Configure as one of the following speed call services: SCU = Speed Call. SSU = System Speed Call. SCC = Speed Call Controller. SSC = System Speed Call Controller.
Key 24	PRS (Privacy Release).

Table 7
M3905 key configuration (Part 2 of 2)

Key Number	Description
Key 25	CHG (Charge Account).
Key 26	CPN (Calling Party Number).
Keys 27-31	NUL.

Table 8
LD 20 - Configure print routine.

Prompt	Response	Comment
REQ	PRT	Print request.
TYPE	axxxx	Enter appropriate telephone model. axxx = M3901. axxx = M3902. axxx = M3903. axxx = M3904. axxx = M3905.
...

Hardware options

Table 9 lists the features and optional hardware available for each telephone

Table 9
Hardware Features

Optional hardware available	M3901	M3902	M3903	M3904	M3905
Non-amplified Headset Accessory connected through Headset Jack	NA	NA	Supports	Supports	Supports
Amplified Headset Accessory connected through Handset Jack	Supports	Supports	Supports	Supports	Supports
Handset	Standard	Standard	Standard	Standard	Optional
Accessory Connection Module (ACM)	NA	Supports	Supports	Supports	Supports
Key-based Expansion Module	NA	NA	NA	Supports	Supports
Meridian Communications Adapter (MCA)	NA	Supports	Supports	Supports	Supports
Analog Terminal Adapter (ATA)	NA	Supports	Supports	Supports	Supports
External alerter interface	NA	Supports	Supports	Supports	Supports
Note: X indicates the hardware is available for that model of the M3900 Series Meridian Digital Telephone.					

Handset option for the M3905 Call Center Telephone

The M3905 supports an amplified headset or an optional handset. The handset can be added to the M390 by removing the front plate of the telephone. A handset kit is available for the M3905.

The M3903, M3904 and M3905 have a dedicated headset jack which supports a non-amplified headset. The M3903, M3904 and M3905 have a Headset Fixed Feature Key to turn the Headset on and off.

Headset options

The M3901, M3902, M3904, and M3905 supports an amplified headset when the headset connects to the handset jack.

The M3903, M3904 and M3905 have a dedicated headset jack which supports a non-amplified headset. The M3903, M3904 and M3905 have a Headset Fixed Feature Key to turn the Headset on and off.

External Alerter and Recording Interface

The External Alerter and Recording Interface provides a remote ringer device installed in a location separate from the telephone. The External Alerter and Recording Interface provides access to a standard, off-the-shelf remote ringer, call status relay, audio recorder or visual indicator.

You can program the External Alerter interface to activate a ringer (or light) when the telephone rings or when the telephone is in use (off-hook).

Key-based Expansion Module

The Key-based Expansion Module attaches to the M3904 and M3905 Meridian Digital Telephone. The module provides 22 additional Line/Feature Keys. You can attach a maximum of two Key-based Expansion Modules to the M3904 and M3905.

Analog Terminal Adapter

The Analog Terminal Adapter (ATA) lets you connect an analog device such as a fax machine or modem to your telephone. You can have simultaneous use of the telephone and the analog device. The ATA is available for the M3902, M3903, M3904 and the M3905 models.

Meridian Communications Adapter

The Meridian Communications Adapter (MCA) lets the user connect the telephone to a personal computer or terminal. The MCA allows the telephone to exchange data between your computer and other computers. The M3902, M3903, M3904 and M3905 models support the MCA.

Installation

To install the M3900 Series Meridian Digital Telephones:

- 1 Complete the wiring and cross-connections (loop power).
- 2 Connect the telephone to the connecting block.
- 3 Place the telephone upright on the desk in the normal operating position.
- 4 Perform the self test and acceptance procedures found in the *Telephone and attendant console installation (553-3001-215)*.
- 5 Supply the user with a quick reference guide.

To install the ACM:

Please refer to Figure 6 on page 30.

- 1 Slide the footstand down (using the plastic hinges) about a quarter of and pull the footstand away from the telephone base.
- 2 Snap the ACM into the rectangular opening on the back of the telephone.
- 3 Connect the ACM cable to the back of the telephone.
- 4 Put the ACM attached ribbon cable into the track running down the back of the telephone base.
- 5 Put the hard plastic cable cover over the ACM ribbon cable.
- 6 Snap the ACM plastic cable cover into place.
- 7 Place the footstand on the hinges.
- 8 Swing the footstand back into place.
- 9 Snap the footstand into a non-movable position.
- 10 Return the telephone to an upright position.

There is a cut out on the base of the footstand which displays the ACM connector ports. When ready to attach an accessory, insert the appropriate cartridge into the port slot. There is one accessory port available on the M3902. There are two accessory ports available on the M3903, M3904 and M3905.

Figure 6
Installation of the Accessory Connection Module (ACM)

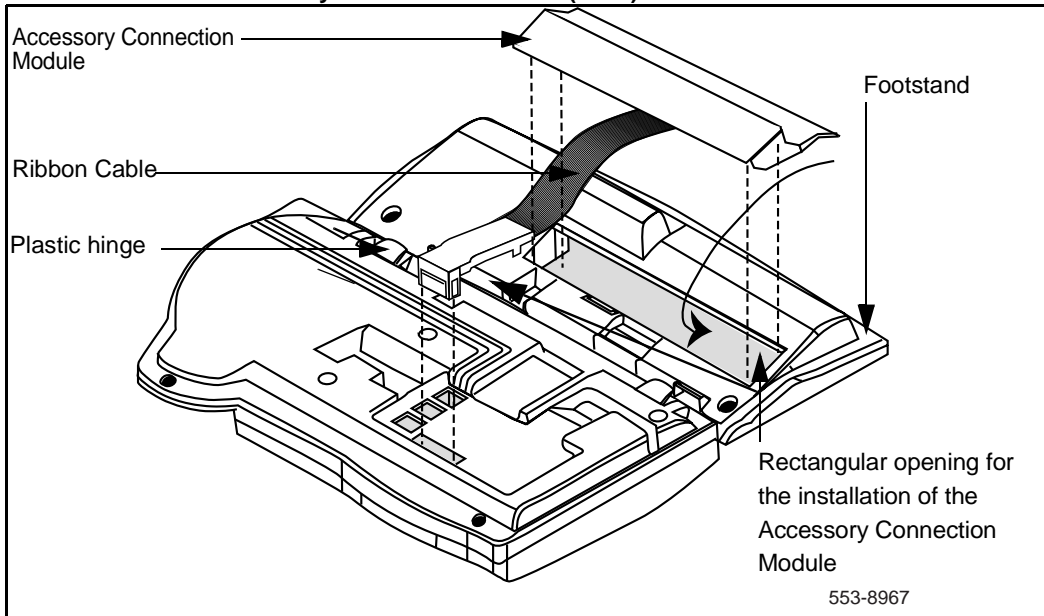

Note: The accessories you attach to the telephone must be compatible. The table “M3900 Series Meridian Digital Telephone accessory compatibility” on page 31 shows the compatibility of the available options.

Accessory keying

There are two accessory ports on the back of the terminal footstand. Each port can support one cartridge accessory. The ports provide access to a SIDL/SDI ports, a USART port, and a Non-Serial Accessory port.

You cannot use two accessories that require the same port type at the same time. For example, you cannot use two accessories that require a serial port connection at the same time.

The shape and size of the plug in accessory cartridge prevents the user from accidentally connecting incompatible accessories. To check the compatibility of accessories refer to Table 10 which shows the optional accessories and their compatibility.

Make sure you refer to the compatibility chart before you purchase your optional hardware accessories.

Table 10
M3900 Series Meridian Digital Telephone accessory compatibility

Accessory	MCA	ATA	DTA	USB	CTIA	DBA	KBA	Headset Port		Headset Port	
								EXT.ART*	HD/S	EXT. ART**	RCDR
MCA	No	No	No	No	Yes	Yes	Yes	Yes	Yes	Yes	Yes
ATA	No	No	No	No	Yes	Yes	Yes	Yes	Yes	Yes	Yes
DTA	No	No	No	No	Yes	Yes	Yes	Yes	Yes	Yes	Yes
USB	No	No	No	No	No	Yes	Yes	Yes	Yes	Yes	Yes
CTIA	Yes	Yes	Yes	No	No	Yes	Yes	Yes	Yes	Yes	Yes
DBA	Yes	Yes	Yes	Yes	Yes	No	No	Yes	Yes	Yes	Yes
KBA	Yes	Yes	Yes	Yes	Yes	No	Yes	Yes	Yes	Yes	Yes
EXT.ATR*	Yes	Yes	Yes	Yes	Yes	Yes	Yes	No	No	Yes	No
HD SET	Yes	Yes	Yes	Yes	Yes	Yes	Yes	No	No	Yes	Yes
EXT.ATR	Yes	Yes	Yes	Yes	Yes	Yes	Yes	Yes	Yes	No	Yes
RCDR	Yes	Yes	Yes	Yes	Yes	Yes	Yes	No	Yes	Yes	No

Note 1: Yes = compatible accessories. No = non-compatible accessories.

Note 2: EXT. ATR** = Cartridge External Alerter plugs into ACM.

Note 3: EXT ATR* = External Alerter plugs into Headset Jack.

Telephone positions

Your M3903, M3904 and M3905 Meridian Digital Telephones have ten different height selections for the desktop positions. To change the telephone position:

- 1 Press the bar at the top back side of the telephone.
- 2 With the position bar pressed in, raise or lower the telephone to the desired angle or height.
- 3 Release the bar to lock the telephone in the desired position.

Note: The M3903 and M3904 can be wall mounted.

The M3901 and M3902 Meridian digital Telephones have three different angled height desktop positions. To change the telephone angle:

- 1 Move the top of the footstand away from the telephone base (it has a snap connection).
- 2 Place the footstand in the desired position and snap the top of the footstand back into place.

Environmental and safety considerations

Temperature and humidity

Operating state:	
Temperature range	0° to 50°C (32° to 104°F)
Relative humidity	5% to 95% (noncondensing). At temperatures above 34°C (93°F) relative humidity limited to 53 mbar of water vapor pressure.

Storage:	
Temperature range	-50° to 70°C (-58° to 158°F)
Relative humidity	5% to 95% (noncondensing). At temperatures above 34°C (93°F) relative humidity limited to 53 mbar of water vapor pressure.

Line engineering

The M3900 Series Meridian Digital Telephones use twisted pair wiring on transmission lines determined by the rules in *Digital telephone line engineering* (553-2201-180). The maximum acceptable loop length is 1067 m. (3500 ft), assuming 24 AWG (0.5 mm) standard twisted wire with no bridge taps. A 15.5 dB loss at 256 kHz defines the loop length limit. Longer lengths are possible, depending on the wire's gauge and insulation.

CAUTION

Use only the line cord provided with the telephone. A line cord designed for another telephone can cause damage to the equipment.

List of Acronyms

ACD	Automatic Call Distribution
ACM	Accessory Connection Module
ADO	Asynchronous Data Option
ATA	Analogue Terminal Adapter
COS	Class of Service
CCOS	Controlled Class of Service
CPM	Call Progress Monitor
CPND	Calling Party Name Display
DCE	Data Communications Equipment
DLC	Digital Line Card

DN	Directory Number
EIA	Electronic Industries Association
FCC	Federal Communications Commission
IDF	Intermediate Distribution Frame
LCD	Liquid Crystal Display
LED	Light Emitting Diode (lamp)
MDF	Main Distribution Frame
MCA	Meridian Communications Adapter
MPA	Meridian Communications Adapter
TN	Terminal Number

M3900 Series

Meridian Digital Telephones

Description, Installation and Administration

© 1999, 1999 Nortel Networks Corporation

All rights reserved

Information is subject to change without notice. Nortel Networks Corporation reserves the right to make changes in design or components as progress in engineering and manufacturing may warrant. This equipment has been tested and found to comply with the limits for a Class A digital device pursuant to Part 15 of the FCC rules, and the radio interference regulations of Industry Canada. These limits are designed to provide reasonable protection against harmful interference when the equipment is operated in a commercial environment. This equipment generates, uses and can radiate radio frequency energy, and if not installed and used in accordance with the instruction manual, may cause harmful interference to radio communications. Operation of this equipment in a residential area is likely to cause harmful interference in which case the user will be required to correct the interference at their own expense.

SL-1 and Meridian 1 are trademarks of Nortel Networks Corporation.

Publication number: 553-3001-216

Document release: Standard 1.00

Date: June 1999

Printed in the United States of America